

# Panel convector heater

**Always read this instruction manual before installing or using your appliance and always keep for future reference**

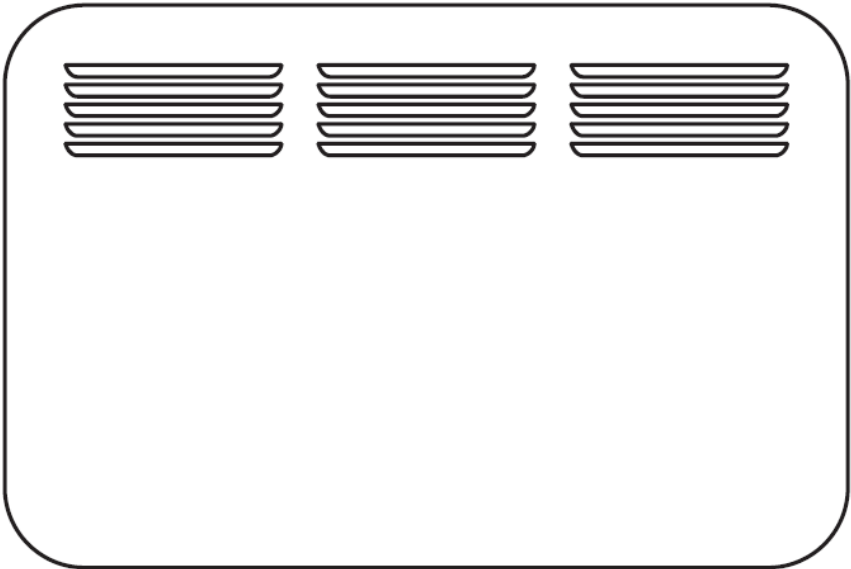

**Model# HPH01-05E/10E/15E/20E**

## Safety Advice

READ THIS NOTICE CAREFULLY BEFORE OPERATING THE APPLIANCE.

This appliance can be used by children aged from 8 years and above and persons with reduced physical, sensory or mental capabilities or lack of experience and knowledge if they have been given supervision or instruction concerning use of the appliance in a safe way and understand the hazards involved. Children shall not play with the appliance. Cleaning and user maintenance shall not be made by children without supervision.

- Children of less than 3 years should be kept away unless continuously supervised.

Children aged from 3 years and less than 8 years shall only switch on/off the appliance provided that it has been placed or installed in its intended normal operating position and they have been given supervision or instruction concerning use of the appliance in a safe way and understand the hazards involved. Children aged from 3 years and less than 8 years shall not plug in, regulate and clean the appliance or perform user maintenance.

**CAUTION - Some parts of this product can become very hot and cause burns. Particular attention has to be given where children and vulnerable people are present.**

- If the supply cord is damaged, it must be replaced by the manufacturer, its service agent or similarly qualified persons in order to avoid a hazard.

- CAUTION: In order to avoid a hazard due to inadvertent

resetting of the thermal cutout, this appliance must not be supplied through an external switching device, such as a timer, or connected to a circuit that is regularly switched on and off by the utility.



- **WARNING:** In order to avoid overheating, do not cover the heater.
- The heater must not be located immediately below a socket-outlet.
- Do not use this heater in the immediate surroundings of a bath, a shower or a swimming pool.
- Always use your appliance with rollers or feet fixed.
- Fixed heaters are to be installed so that switches and other controls cannot be touched by a person in the bath or shower.

**Warning: this product shall be installed in the volume 2 only according the national wiring rules (For France NF C 15-100)**

**Note:** The drawing below is for reference only.

We suggest that you contact a professional electrician for assistance.

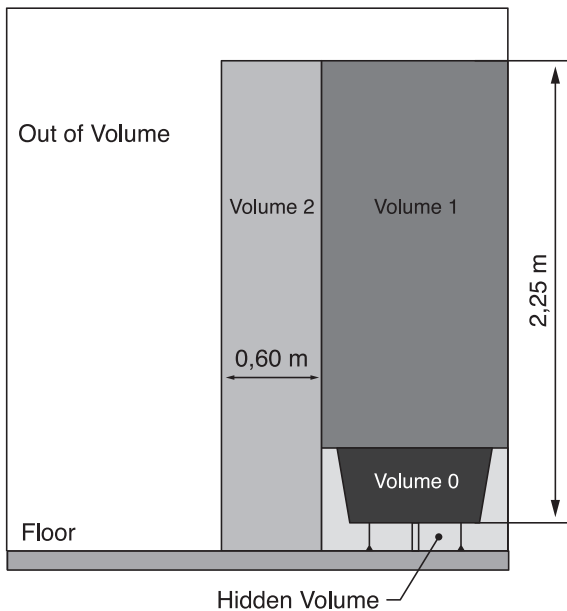

**THIS PRODUCT IS FOR ROOM HEATING**

## Installation

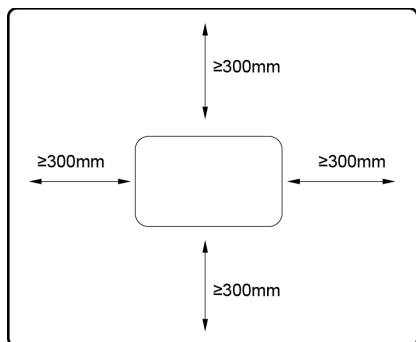

Make sure that the distance from walls and objects is respected.

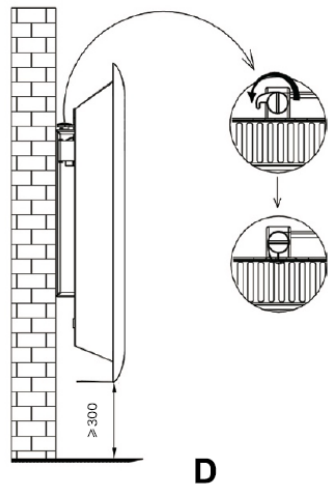
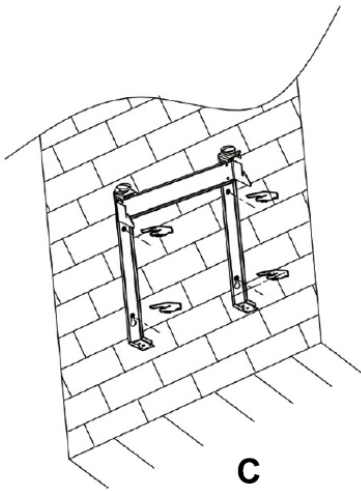
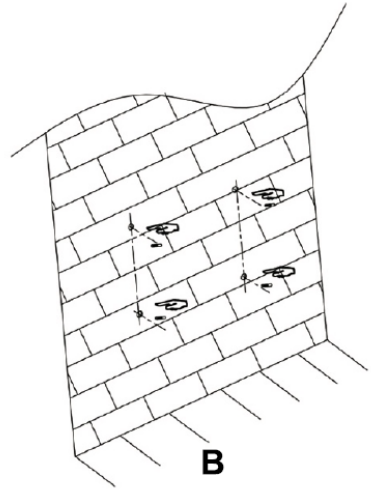
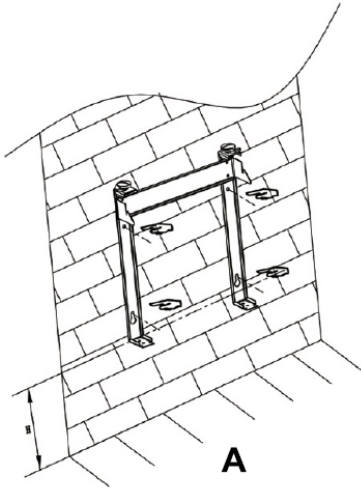

- A. Put the hanging rack on the wall as a guide ruler (please make sure the holes at parallel level) , use a mark pen to mark the hole position
- B. Drill holes on the wall with  $\phi$  8mm drill bit and insert the plastic wall plug
- C. Fasten the hanging rack on the wall with the screws,

do make sure the hanging rack is in correct direction

- D. Gently insert the heater body of the bottom to the hanging rack first and then push the heater body to be hooked on the whole hanging rack

**Warning: Be sure to keep the distance between the heater and floor, wall and so on at least 30cm.**

**Warning! When drilling holes, always check to ensure there is no wiring, pipework, etc. in the area to be drilled.**

**Warning: Before plugging in the unit make sure the radiator is properly attached to the wall. Otherwise problems can occur.**

Put the heater on a flat, dry and clean surface. Install the feet by 4 screws as shown on the below drawing.

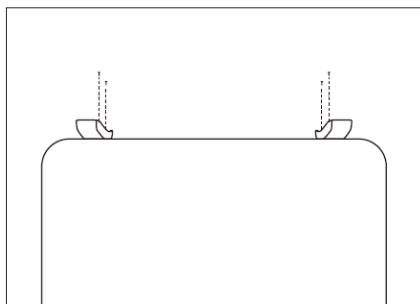
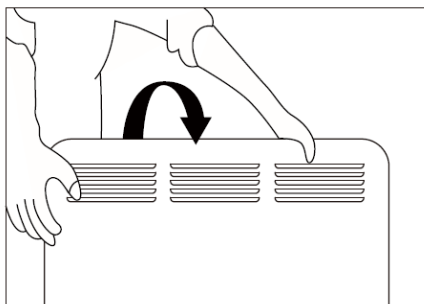

# How to use:

## Control panel

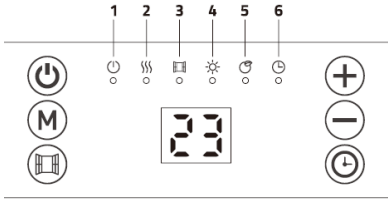

	Standby
	Mode selection
	Open window function
	Increase function
	Decrease function
	Timer

- ① Standby: on/off
- ② Heating status
- ③ Open window function
- ④ Comfort mode
- ⑤ ECO mode
- ⑥ Timer









## How to use:

- Plug the appliance to AC 220-240V 50-60Hz socket, and press down on/off switch with a beep sound. The indicator light is on.
- Press to turn on the heater, which is in state of factory default when first time use.  
 Factory default:  
 Heating mode: comfort mode  
 Target temperature setting: 22 °C  
 Date: 1(Monday); Time: 00:00 (Off)  
 Window open function: Off  
 Timer: Off
- To stop the heater working, press to turn off the heater,
- Unplug the product when it's not in use.



## Clock and day of week setting:

- Press down 3 secs to enter clock and day of week setting
- The screen display "d", press and to select the day from 1-7.





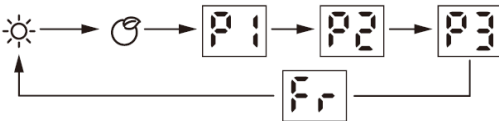

1	Monday
2	Tuesday
3	Wednesday
4	Thursday
5	Friday
6	Saturday
7	Sunday

- Press  to confirm day setting and enter the clock hour setting, with the screen display: .
  - Press  and  to set the current hour
  - Press  to confirm hour setting and enter the minute setting, with the screen display: .
  - Press  and  to set the current minute
  - Press  to confirm all settings
- Note: The clock and calendar will be reset to factory default if without power supply.

## Heating mode:

- Press  to enter mode selection. By pressing , heating mode runs in a continuous cycle as below:



-  Comfort mode: Press  and  to set the temperature from 5-35°C.
-  ECO mode: Press  and  to set the temperature from 1-31 °C.  
Note: ECO mode=Comfort mode - 4 °C
- Anti-frost mode: the screen display . The target temperature is 7 °C. The temperature can't be adjusted.
- P1/P2/P3: Pre-set heating program.  
Note: If the clock and day setting are not finished, the first time to enter P1/P2/P3 program setting, it is requested to set day and clock setting in advance.



P1: (Monday-Sunday) Unadjustable program



P2:(Monday-Friday) Unadjustable program



P2:(Saturday-Sunday) Unadjustable program



P3:(Monday-Friday) Adjustable program



P3:(Saturday-Sunday) Adjustable program



- P3 adjustable program setting

1. When under P3 mode, press **(M)** over 3 secs to enter day setting.

2. The screen displays **d1**, press **(+)** and **(-)** to set from **d1-d7**

(Monday-Sunday). Press **(M)** to confirm and enter hour setting

3. The screen displays **00**, press **(+)** and **(-)** to set from 00-24). Press

**(M)** to choose heating mode for every hour (Comfort mode  or ECO mode





 or anti-frost mode for neither 2 lights)

4. Repeat the operation until you have completed the schedule of every hour and every day.





Note: After setting heating mode for hour 23, press **(+)** to come back to day setting.

Note: when screen displays **d7**, press **(+)** finish all setting with display of **P3**.

## Timer off function

- Press  one time, the indicator light  is on. And the screen display "0 H" and keeps flashing. press  and  to set timer from 0-24 hours. Press  again to confirm setting.

## Open window function

- Press  one time and the indicator light  is on. If open window function is activated, the indicator light  keeps flashing and stops heating.
- Press  again to quit open window function and back to previous working situation.

## CLEANING & MAINTENANCE

- Switch off and unplug from the power supply before cleaning.
- Using a soft, moist cloth, with or without a mild soap solution, carefully clean the exterior surface of the product.
- CAUTION: Allow the product to completely cool before handling or cleaning it.
- Do not allow water or other liquids to run into the interior of the product, as this could create a fire and/or electrical hazard.
- We also recommend the periodic cleaning of this appliance by lightly running a vacuum cleaner nozzle over the guards to remove any dust or dirt that may have accumulated inside or on the unit.
- CAUTION: Do not use harsh detergents, chemical cleaners or solvents as they may damage the surface finish of the plastic components.



This marking indicates that this product should not be disposed with other household wastes throughout the EU. To prevent possible harm to the environment or human health from uncontrolled waste disposal, recycle it responsibly to promote the sustainable reuse of material resources. To return your used device, please use the return and collection systems or contact the retailer where the product was

purchased. They can take this product for environmental safe recycling.